

SiC SBD P3D12015T2

1200V SiC Schottky Diode

Features

- Qualified to AEC-Q101
- Ultra-Fast Switching
- Zero Reverse Recovery Current
- High-Frequency Operation
- Positive Temperature Coefficient on V_F
- High Surge Current
- 100% UIS tested



TO-220-2

Cathode	1
Anode	2

Standards Benefits

- Improve System Efficiency
- Reduction of Heat Sink Requirement
- Essentially No Switching Losses
- Parallel Devices Without Thermal Runaway



Application

- Consumer SMPS
- Boost Diodes in PFC or DC/DC Stages
- AC/DC Converters



Order Information

Part Number	Package	Marking
P3D12015T2	TO-220-2	P3D12015T2



Contents

Features.....	1
Standards Benefits	1
Application.....	1
Order Information	1
Contents.....	2
1. Maximum Ratings.....	3
2. Thermal Characteristics.....	3
3. Electrical Characteristics	4
4. Typical Performance	5
5. Package Outlines.....	6

PNJ Preliminary

1. Maximum Ratings

At $T_J = 25^\circ\text{C}$, unless specified otherwise

Parameter	Symbol	Value	Unit	Test condition
Repetitive Peak Reverse Voltage	V_{RRM}	1200	V	$T_C = 25^\circ\text{C}$
Surge Peak Reverse Voltage	V_{RSM}	1200	V	$T_C = 25^\circ\text{C}$
DC Blocking Voltage	V_R	1200	V	$T_C = 25^\circ\text{C}$
Forward Current	I_F	34 19 15	A	$T_C = 25^\circ\text{C}$ $T_C = 125^\circ\text{C}$ $T_C = 142^\circ\text{C}$
Repetitive Peak Forward Surge Current	I_{FRM}	62 33	A	$T_C = 25^\circ\text{C}, t_p = 10\text{ms}$ $T_C = 125^\circ\text{C}, t_p = 10\text{ms}$
Non-Repetitive Forward Surge Current	I_{FSM}	130 120	A	$T_C = 25^\circ\text{C}, t_p = 10\text{ms}$ $T_C = 125^\circ\text{C}, t_p = 10\text{ms}$
Power Dissipation	P_{tot}	158	W	$T_C = 25^\circ\text{C}$
Operating Junction and Storage Temperature	T_J, T_{STG}	-55 to +175	$^\circ\text{C}$	
TO-220 Mounting Torque M3 Screw	T_{Orq}	1 8.8	Nm lbf-in	

2. Thermal Characteristics

Parameter	Symbol	Values	Unit
Thermal Resistance from Junction to Case	$R_{\theta JC}$	0.95	$^\circ\text{C}/\text{W}$

3. Electrical Characteristics

At $T_J = 25^\circ\text{C}$, unless specified otherwise

Parameter	Symbol	Values			Unit	Test condition
		Min.	Typ.	Max.		
Forward Voltage	V_F	/	1.5	1.8	V	$I_F = 15\text{A}, T_J = 25^\circ\text{C}$
			2.4	/		$I_F = 15\text{A}, T_J = 175^\circ\text{C}$
Reverse Current	I_R	/	3.5	50	μA	$V_R = 1200\text{V}, T_J = 25^\circ\text{C}$
			679	/		$V_R = 1200\text{V}, T_J = 175^\circ\text{C}$
Total Capacitance	C	/	831	/	pF	$V_R = 0\text{V}, T_J = 25^\circ\text{C}$ $f = 1\text{MHz}$
			51			$V_R = 400\text{V}, T_J = 25^\circ\text{C}$ $f = 1\text{MHz}$
			48			$V_R = 800\text{V}, T_J = 25^\circ\text{C}$ $f = 1\text{MHz}$
Total Capacitive Charge	Q_C	/	57.8	/	nC	$V_R = 800\text{V}, I_F = 15\text{A}$ $di/dt = 200\text{A}/\mu\text{s}$ $T_J = 25^\circ\text{C}$
Capacitance Stored Energy	E_C	/	15.5	/	μJ	$V_R = 800\text{V}$

4. Typical Performance

At $T_J = 25^\circ\text{C}$, unless specified otherwise

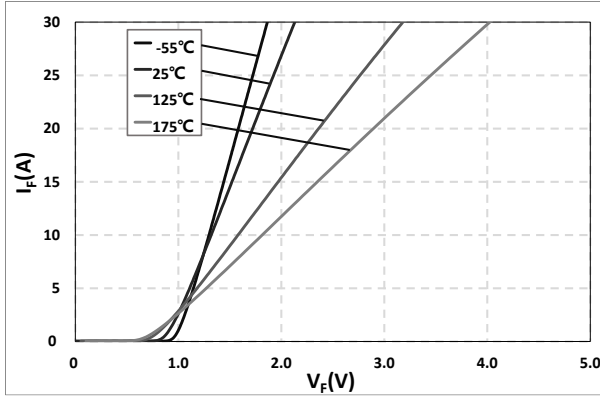

Fig. 1 Typical Forward Characteristics
 $I_F = f(V_F)$; $T_J = -55^\circ\text{C}, 25^\circ\text{C}, 125^\circ\text{C}, 175^\circ\text{C}$

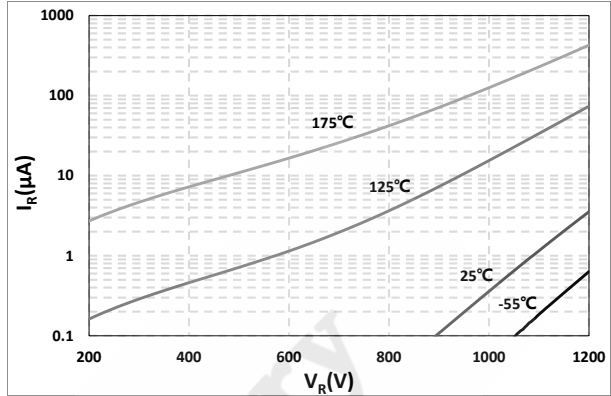

Fig. 2 Reverse Characteristics
 $I_R = f(V_R)$; $T_J = -55^\circ\text{C}, 25^\circ\text{C}, 125^\circ\text{C}, 175^\circ\text{C}$

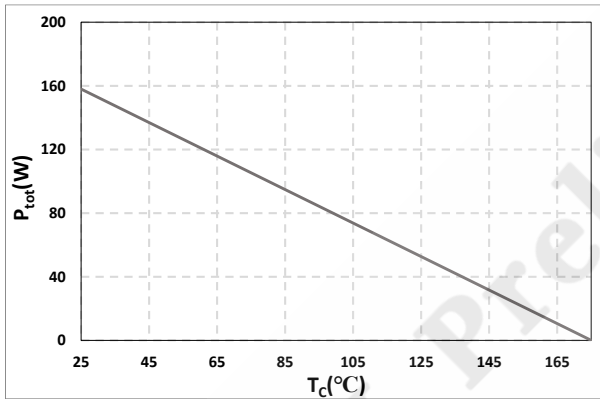

Fig. 3 Typical Power Derating
 $P_{\text{tot}} = f(T_c)$

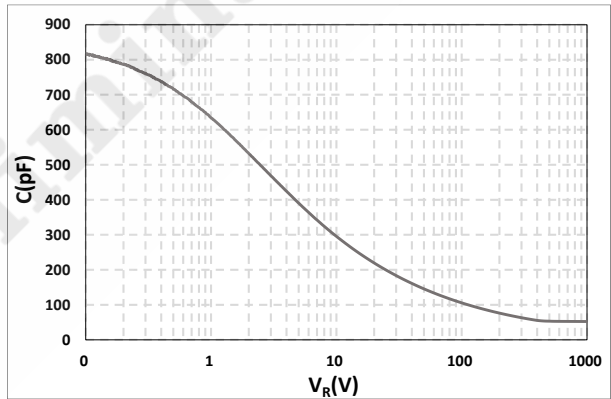

Fig. 4 Typical Total Capacitance
 $C = f(V_R)$

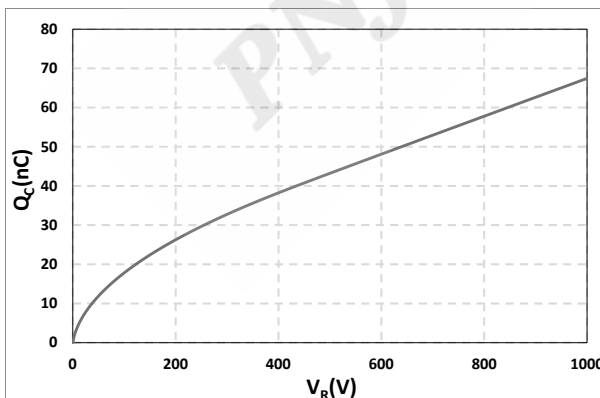

Fig. 5 Typical Total Capacitive Charge
 $Q_C = f(V_R)$

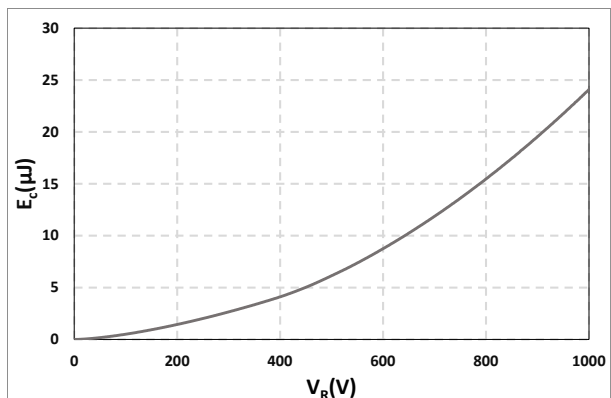
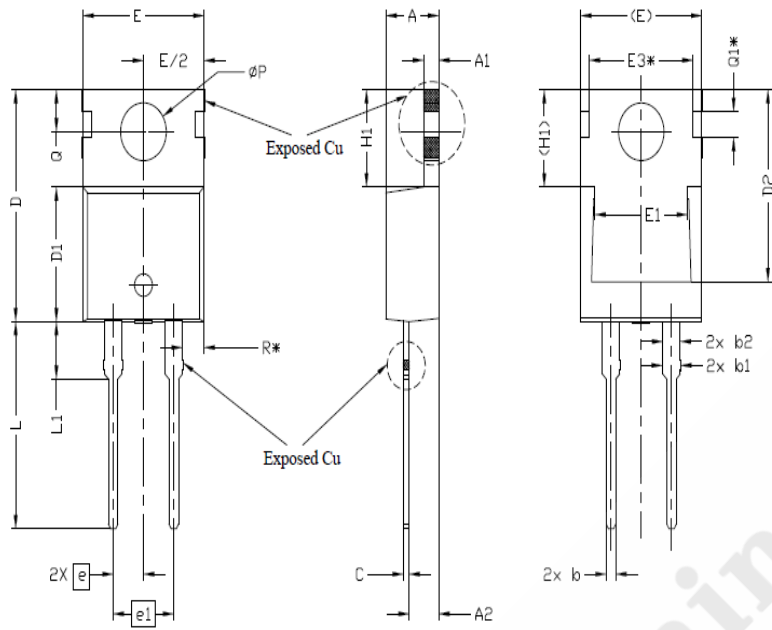

Fig. 6 Capacitance Stored Energy
 $E_C = f(V_R)$

5. Package Outlines



SYMBOL	DIMENSIONS			NOTES
	MIN.	NOM.	MAX.	
A	4.24	4.44	4.64	
A1	1.15	1.27	1.40	
A2	2.30	2.48	2.70	
b	0.70	0.80	0.90	
b1	1.20	1.55	1.75	
b2	1.20	1.45	1.70	
c	0.40	0.50	0.60	
D	14.70	15.37	16.00	4
D1	8.82	8.92	9.02	
D2	12.63	12.73	12.83	5
E	9.96	10.16	10.36	4,5
E1	6.86	7.77	8.89	5
E3*	8.70REF.			
e	2.54BSC			
e1	5.08BSC			
H1	6.30	6.45	6.60	5,6
L	13.47	13.72	13.97	
L1	3.60	3.80	4.00	
$\varnothing P$	3.75	3.84	3.93	
Q	2.60	2.80	3.00	
Q1*	1.73REF.			
R*	1.82REF.			

Drawing and dimensions

PNJ Preliminary